



Atlas Copco



LRP 700 – 1000 VSD⁺

Intelligent Liquid Ring Vacuum Pump

A culture of innovation and collaboration

Atlas Copco's culture is one of innovation, continually pushing the limits of possibility, forging and fostering new ideas and making them reality. We do not develop our products in isolation yet listen intently to our customers to develop truly game changing technologies that suit their real world needs. This customer focused approach is one of the key pillars of our innovation culture and process.

New breakthroughs in proven technology

Liquid ring vacuum technology is perfectly suited to wet, humid and dirty applications across many industries. In these applications the pump will face high temperatures, extreme vapor loads and even liquid and solid carry over from the process. Atlas Copco's Intelligent liquid ring pumps build on this foundation and through game changing innovation take the next step in LRP evolution. We now introduce our revolutionary product, the LRP 700-1000 VSD⁺.

The LRP VSD⁺ is a truly unique liquid ring vacuum pump, offering best in class performance and connectivity. It is a state-of-the-art vacuum solution that provides optimum energy efficiency along with low operational and maintenance costs. Its ease of use, integration and centralization capabilities are unrivalled. No other liquid ring vacuum pump offers this level of efficiency and economy, while maintaining the highest degree of standard build scope and quality.

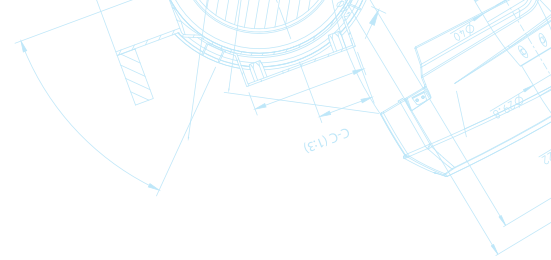

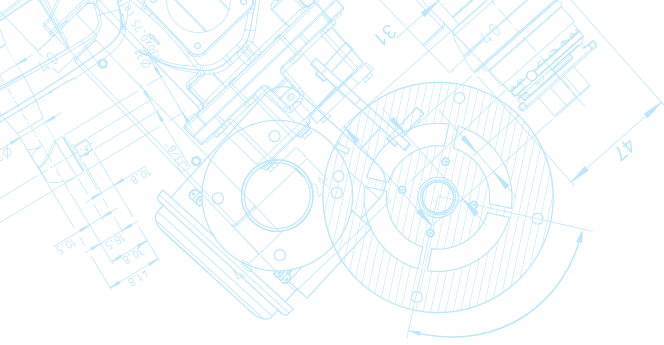

Cleverly engineered in a smart design

Atlas Copco's LRP 700-1000 VSD+ is unique in many ways. The core of the pump is innovative engineering and optimised design which is then enclosed under a strong canopy ensuring this pump is as robust as it is beautiful. This sleek look is also ergonomic - HMI, inlet, outlet and main cable connections are all located at easy to reach positions on top of the canopy – making this a truly plug and play product.

The compact nature of the pump is also striking, having one of the smallest footprints per unit capacity means that the LRP VSD+ saves space without compromising performance. This tidy unit does not sacrifice functionality either, included in the pump are a host of performance optimising accessories that would normally take up additional space, piping and installation work. The LRP VSD+ is delivered in a single neat enclosure.

Having a noise containing, IP54 rated cubicle, the LRP VSD+ significantly reduces noise pollution and is resistant to dust and water from any direction. Making it ideally suited for tough applications and environments. The canopy follows a wet/dry design principle. The critical electronics within the pump are protected from the wet and humid inflow from the process side. This feature extends the lifetime of electronic components and leads to a longer Mean Time Between Maintenance (MTBM).



- Distinctive compact design ~70% space saving
- Plug and play principle
- Inlet – Outlet and mains cable entry at the top
- IP54 Cubicle with Neos NEMA 4 inverter and Mk5 controller
- Wet/dry concept
- Noise containing canopy ~ 69 dBA



A heritage of reliability and resilience



Taking a proven Hick Hargreaves design that already draws on over 150 years of engineering excellence and infusing Atlas Copco innovation has resulted in one of the most intelligent and resilient pumps in the industrial vacuum market today. The LRP 700-1000 VSD⁺ offers optimized performance through VSD⁺ set point control and improved internal geometry. With stainless steel impeller, endplates, liquid reservoir and heat exchanger the LRP 700-1000 VSD⁺ has a high resilience against corrosion and harsh process gases. Along with the robust nature of the pump, the design allows for ease of serviceability when required. Multiple features have been introduced with this in mind, reducing the amount of time needed to service the pump to an absolute minimum.



- Horizontal serviceability, no need to position the pump vertically
- No oil, no regular filter exchange
- Mechanical seals – eliminate leaking gland sealing
- Lantern flange arrangement – automatic alignment of the motor
- Removable heat exchanger with flexible piping for continued operation
- Ease of cleaning the vessel by convenient access port

A Liquid Ring Pump in absolute harmony using twin VSD

VSD for set point control



Our LRP 700-1000 VSD+ has not one VSD, but two! The first VSD is for the vacuum set point control to maintain and match required vacuum levels. This allows you to optimize your energy consumption by accurately maintaining the required vacuum level to suit your process. The minimum required flow is maintained by altering the motor speed as needed. With no wastage, you optimize your process efficiency and performance. LRP 700-1000 VSD+ delivers exactly to the process demand and consumes only for what is required. It is the perfect vacuum arrangement.

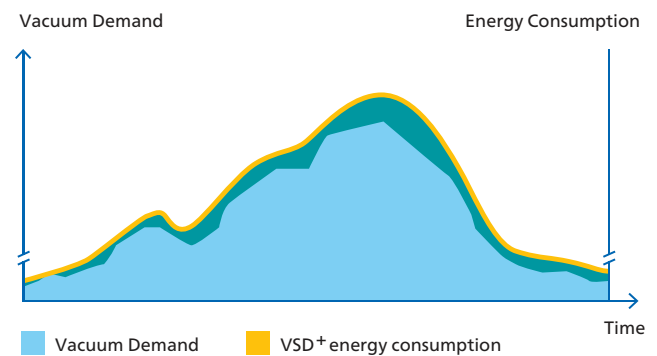
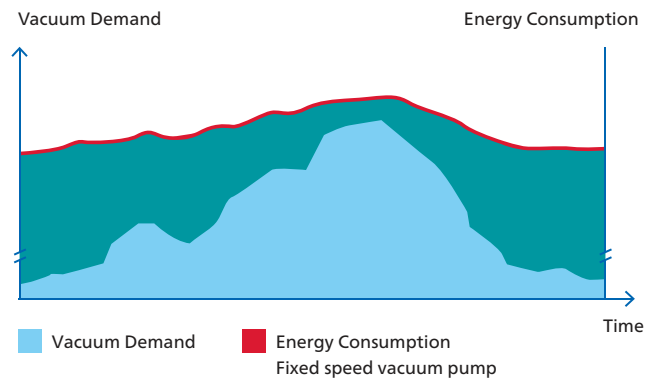

VSD for water control



The second VSD regulates the water circulation pump optimizing water flow and maintaining stable vacuum levels throughout the operating range and pump running speeds. Coupled with the integrated inlet spray nozzles, the inverter driven circulation pump safeguards the LRP 700-1000 VSD+ performance even at lower inlet pressures.

A patented algorithm to balance the operation of the water pump with the speed of the main motor brings a harmony between the twin VSD. Guaranteeing that the pump is always in a state of optimal performance and bringing maximum energy efficiency for our customers.

The Automatic Seizure Prevention algorithm safeguards the LRP 700-1000 VSD+ by preventing the pumping element from seizure after a prolonged period of inactivity. The result - maximized lifetime and reduced maintenance requirements.

Smart monitoring and remote controllability

Elektronikon®

The Atlas Copco MkV Elektronikon® controller is a standard feature of the LRP VSD+ series. Elektronikon® is a state-of-the-art monitoring system for your vacuum pumps. It is user friendly, comprehensive and powerful. It can also integrate your plant management system for full pump and therefore vacuum process control.

The Elektronikon® also provides market leading feedback on the status of your LRP 700-1000 VSD+ including pump operating status, set point control and inlet conditions to name a few. Access all of the information for everyday management of your vacuum pump such as warning alarms, safety shutdowns and maintenance information.

ES Central Controllers

Atlas Copco's ES central controllers allow you to monitor and control multiple LRP VSD+ vacuum pumps simultaneously. Thanks to smart control, the ES gives you the most suitable product performance mix at all times. This maximizes energy savings using set-point control and by mapping equal running hours across multiple installed pumps, keeping servicing requirements to a minimum. The ES controller also allows you to run your vacuum net within a narrow, predefined pressure band. This increases the stability of the process and optimizes overall energy consumption.

ESv connectivity



SMARTLINK

Through activation of Atlas Copco's **SMARTLINK**; central vacuum systems and individual LRP VSD+ are connected to your engineering team. The potential for a game-changing central vacuum system with connected Liquid Ring Vacuum pumps is enormous.

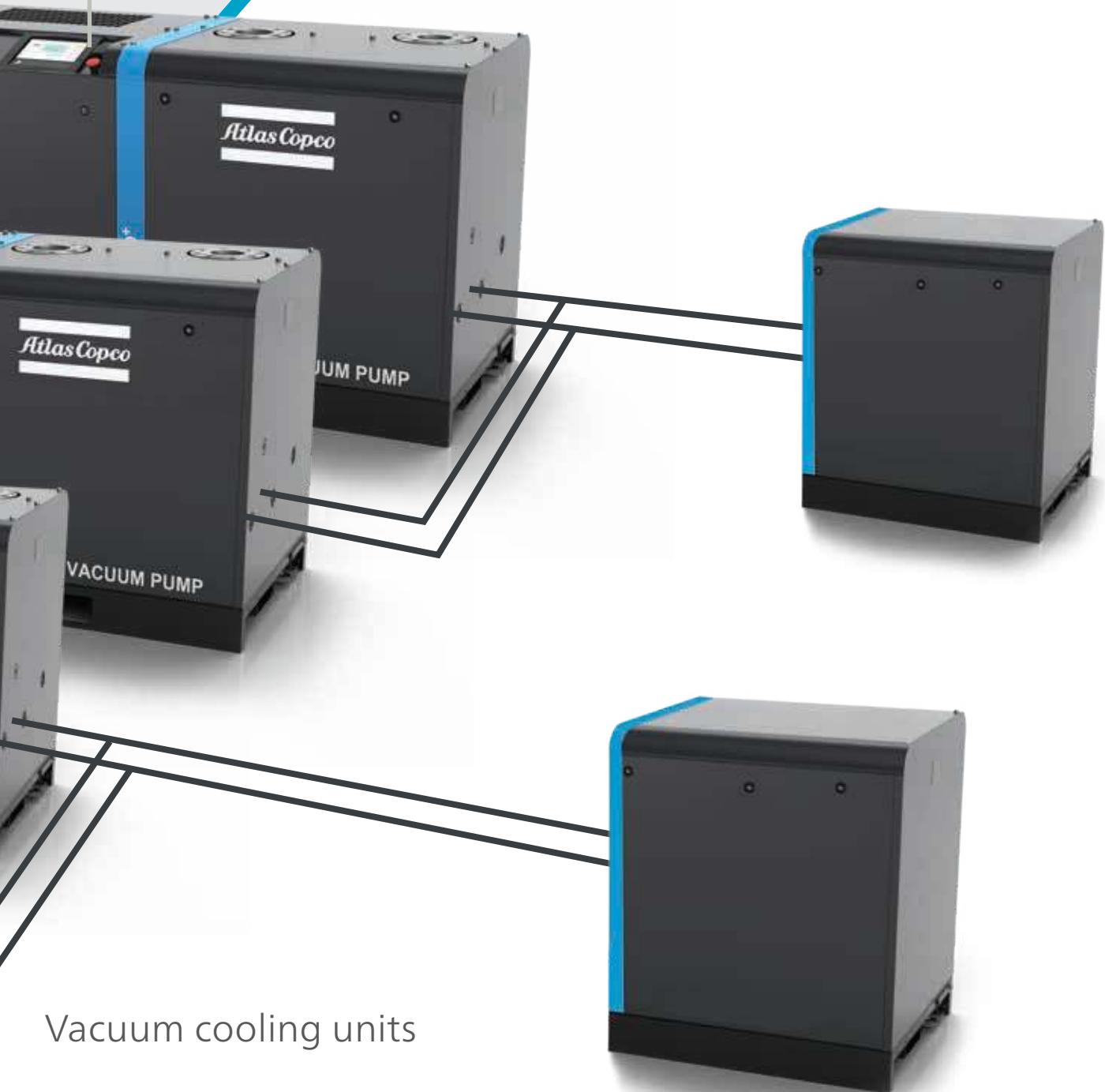

Vacuum cooling units

An energy-efficient, reliable and robust mode of operation

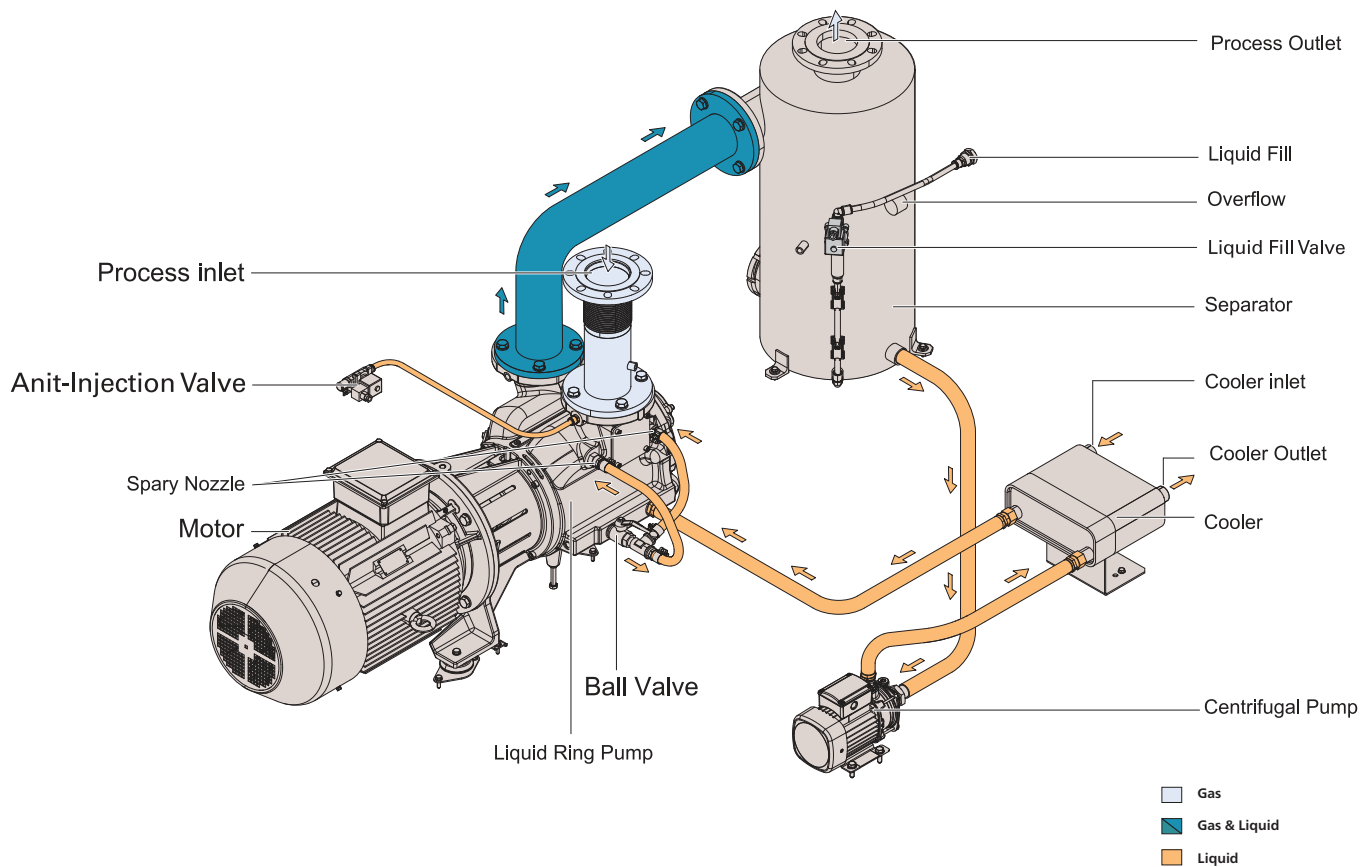

The LRP VSD+ series is the most energy efficient solution for applications with a high vapor load. The closed loop water circuit with integrated heat exchanger ensures the sealant water exiting the pump discharge is collected in the seal liquid reservoir and recirculated. The gained heat load is removed by passing through the stainless-steel heat exchanger contained within the LRP 700-1000 VSD+. All water level monitoring and top-up is a fully automated standard feature of the LRP VSD+.

No more worrying about whether your pump will run out of water or when, with our total recovery mode of operation you can expect improved performance, maximised energy savings and reduced water costs.



Suited for wet and humid applications

The Atlas Copco LRP VSD+ series is ideally suited for humid, wet and harsh applications or where liquid and solid carry over are seen by the pump. Designed for continuous duty, high reliability, efficient operation and high vacuum uptime.

Typical applications are:

- Food Processing:
 - Milk evaporation
 - Bottling
 - Fruit processing
 - Poultry and meat evisceration
- Plastic Extrusion
- Rubber vulcanization and forming
- Pulp and Paper
- Mining
- Drying
- Sterilization
- Evaporation
- Expanded polystyrene forming
- Filtration
- Conveying

Performance curves

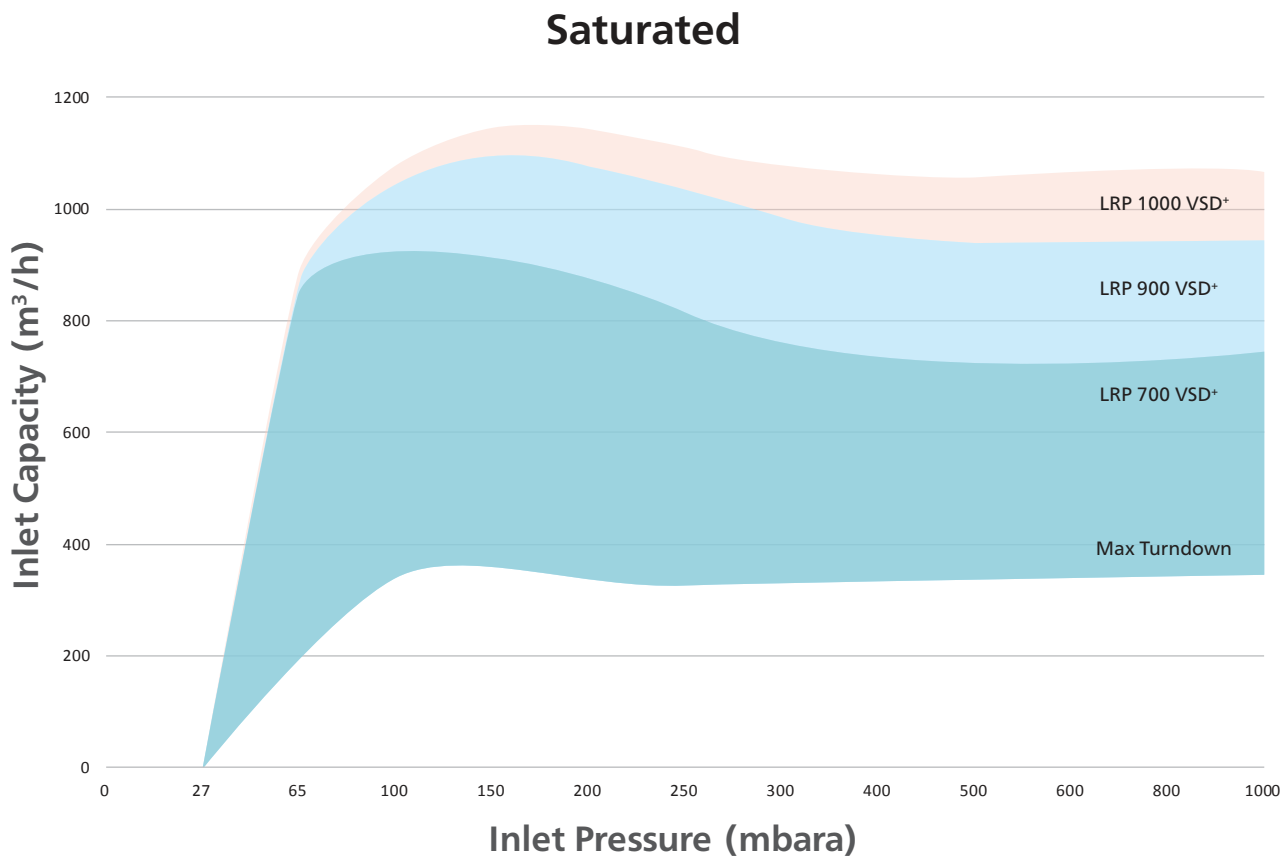
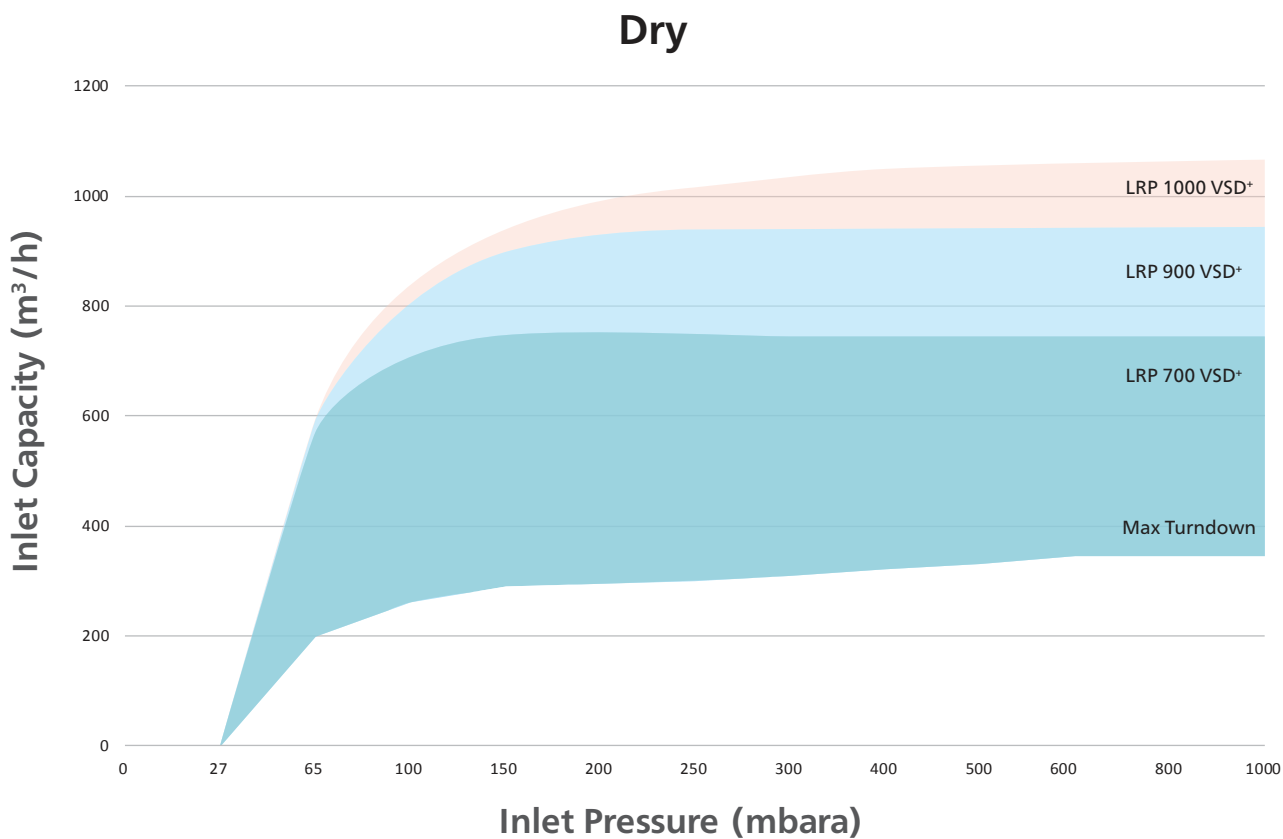

Technical specifications

		LRP 700 VSD ⁺	LRP 900 VSD ⁺	LRP 1000 VSD ⁺
Nominal capacity	Dry-m ³ /h (m ³ /h)	740	940	1050
	Dry-cfm	436	553	618
	Saturated-m ³ /h	910	1090	1140
	Saturated-cfm	536	642	671
Ultimate pressure(Absolute)	mbar	25		
	inch Hg	0.7		
Nominal installed motor	kW	18.5	26	37
	hp	24.8	34.9	49.6
Footprint	mm	1950 x 810 x 1020		
(WxDxH)	inch	76,8 x 31,9 x 40,2		
Connection	Inlet/ Outlet	EN1092-1/01/B1/DN100/PN10		
	Liquid fill/ Manual drain	G 1/2" BSP(F)		
	Overflow	G 1" BSP(F)		
	Cooler inlet/ Outlet	ISO 228/1-G1"		
Dry weight	kg	820	885	900

Optional

- Once through operation
- Shell and tube heat exchanger



